

GE 7 230/CEE
110/CEE

ETL-Nr. 458.740 Blatt 1

Stand 01-2022

status-date 01-2022

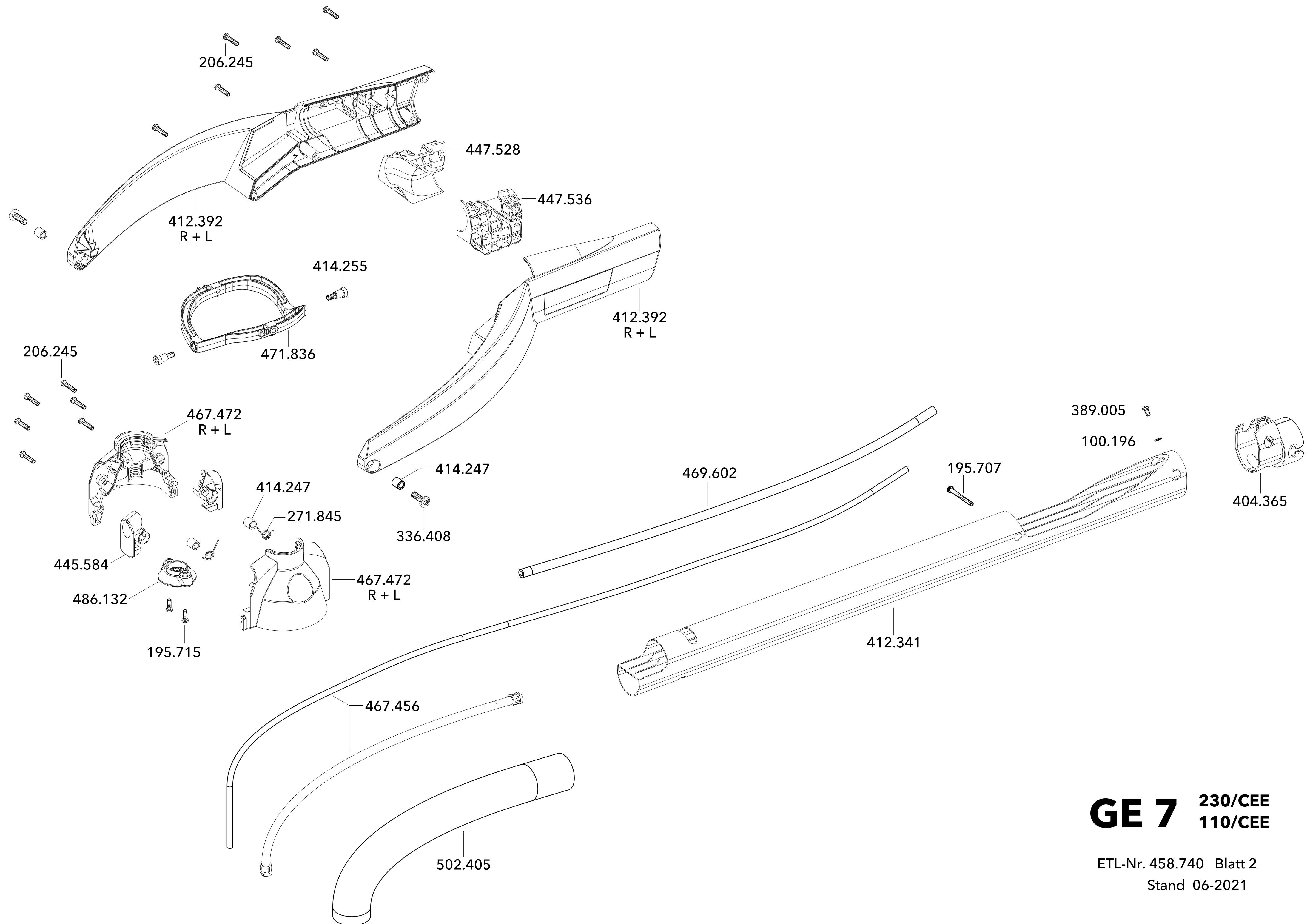

GE 7 230/CEE
110/CEE

ETL-Nr. 458.740 Blatt 2
Stand 06-2021

MH-R D225

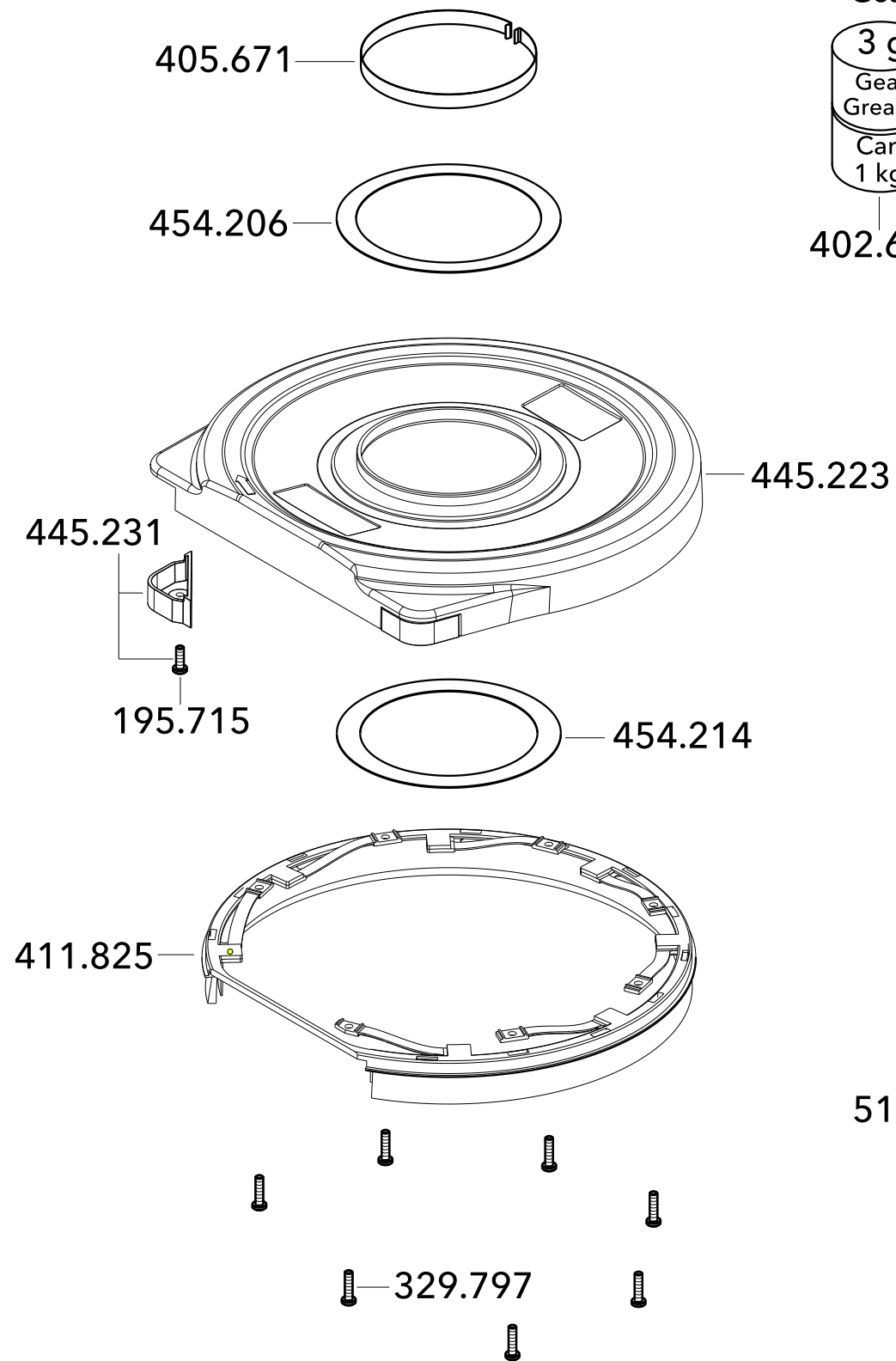

Planetary
Gear
3 g
Gear
Grease
Can
1 kg

402.648

Planeten-
Getriebe
3 g
Getriebe
Fett
Dose
1 kg

402.648

208.450

486.949

445.606

510.459

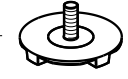
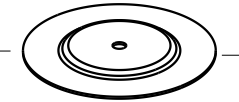
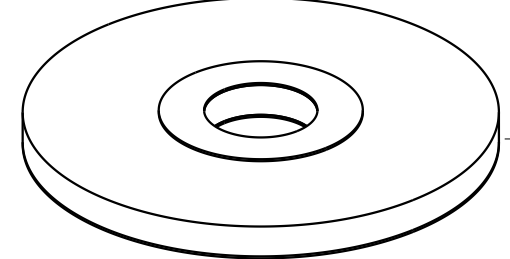
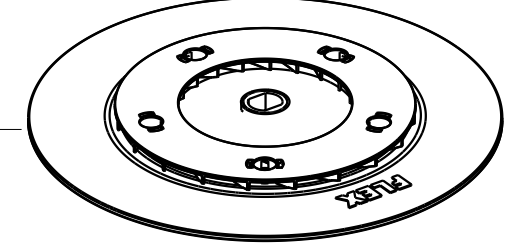
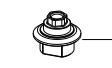
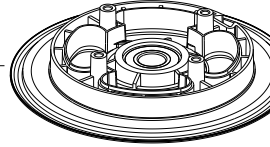
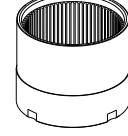
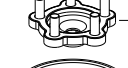
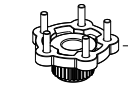
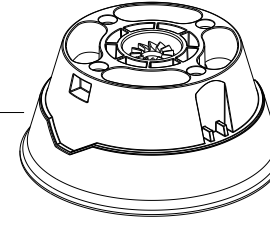
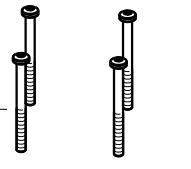

MH-O D225

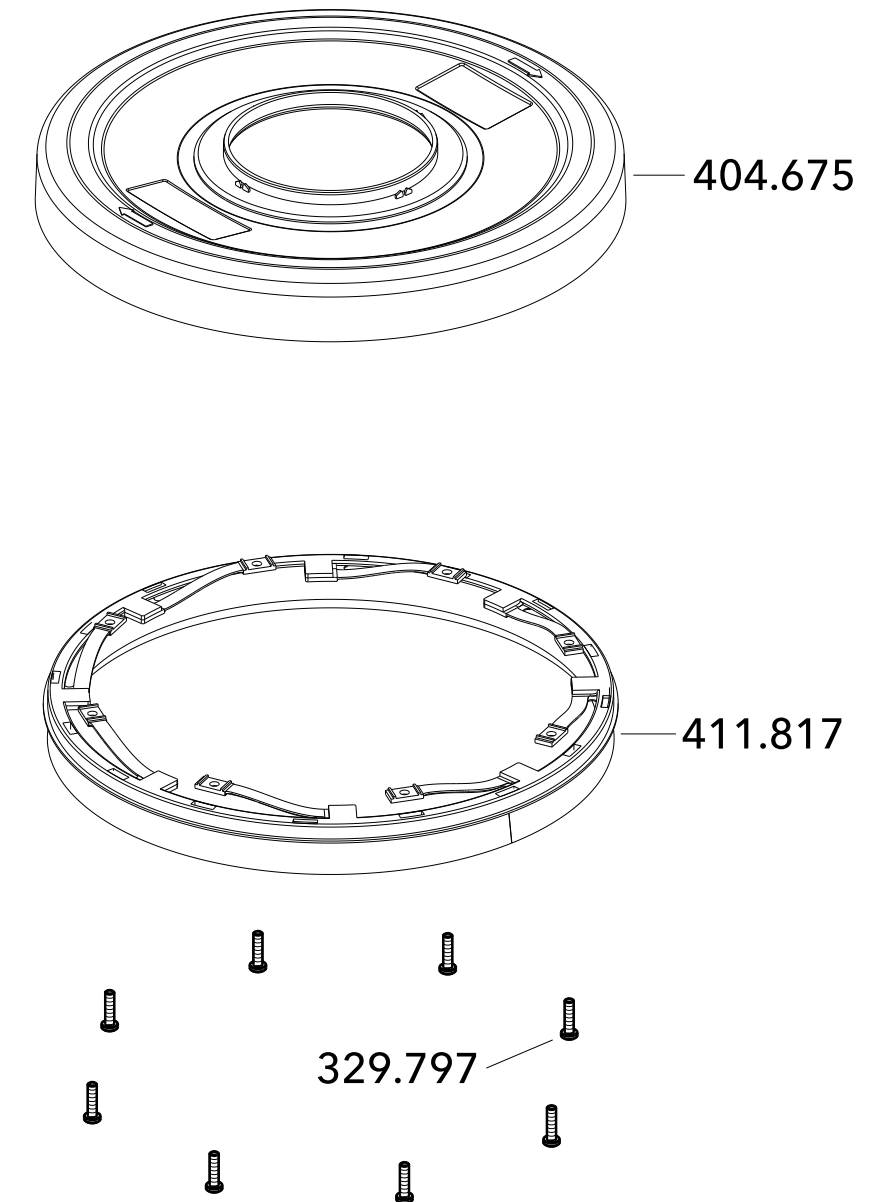

GE 7 230/CEE
110/CEE

ETL-Nr. 458.740 Blatt 3

Stand 07-2021

MH-T 290x290

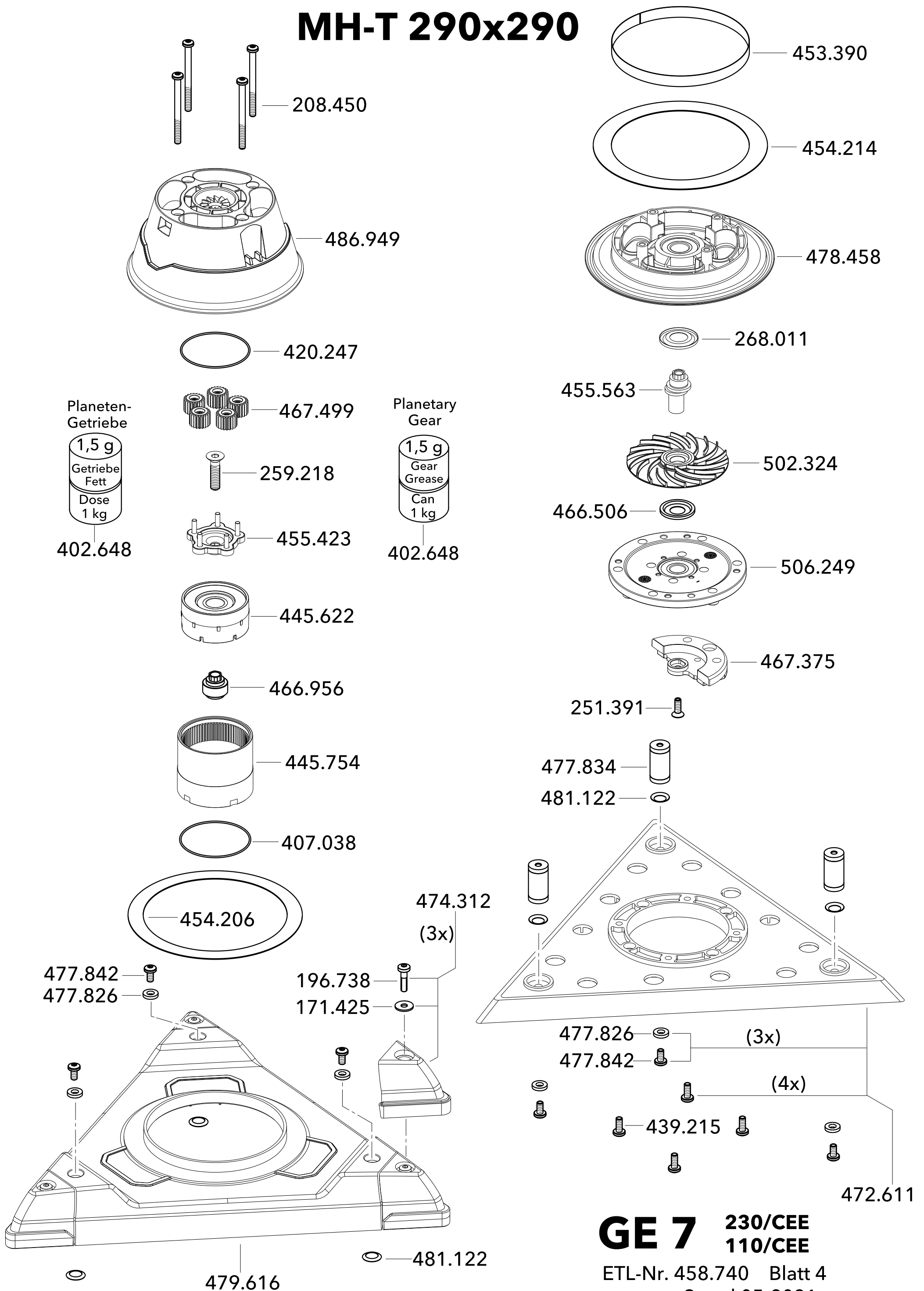

**GE 7 230/CEE
110/CEE**

ETL-Nr. 458.740 Blatt 4

Stand 05-2021

status-date 05-2021

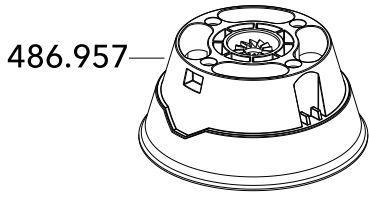
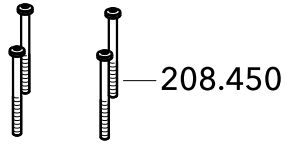

MH-X D225

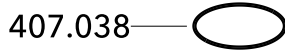
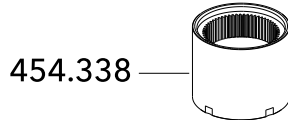
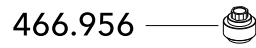
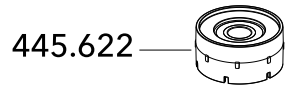
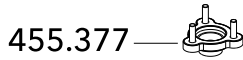
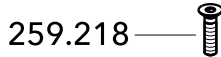
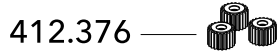
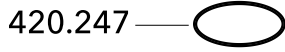

Planeten-
Getriebe



402.648

Planetary
Gear

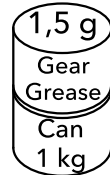

402.648

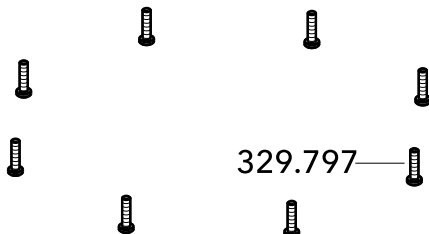
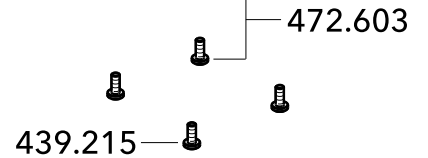
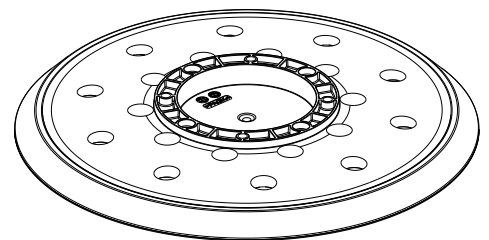
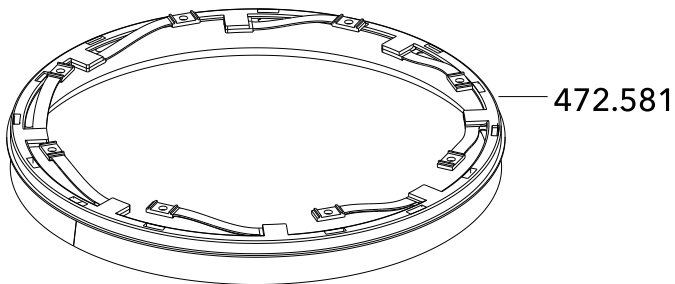
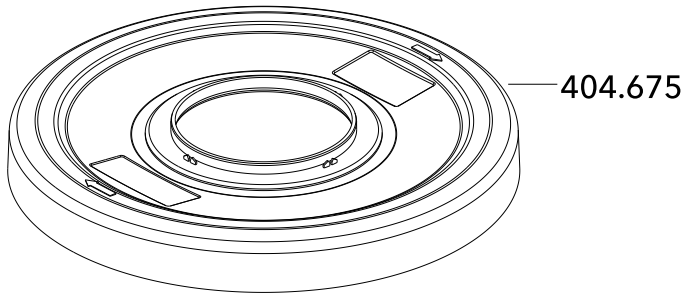
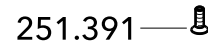
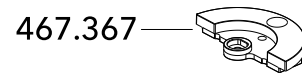
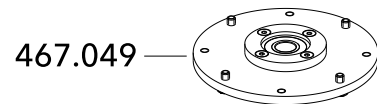
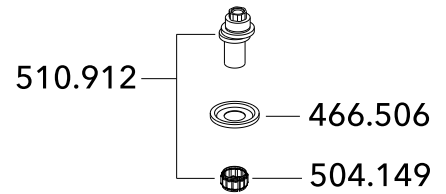
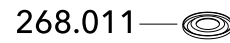
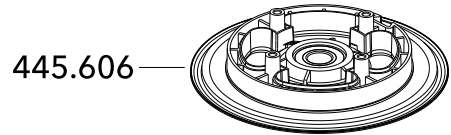

GE 7 230/CEE
110/CEE

ETL-Nr. 458.740 Blatt 5
Stand 02-2021